

## SINGLE DOOR, SURFACE MOUNT (PULL) OFFSET PIVOT/BUTT HINGE

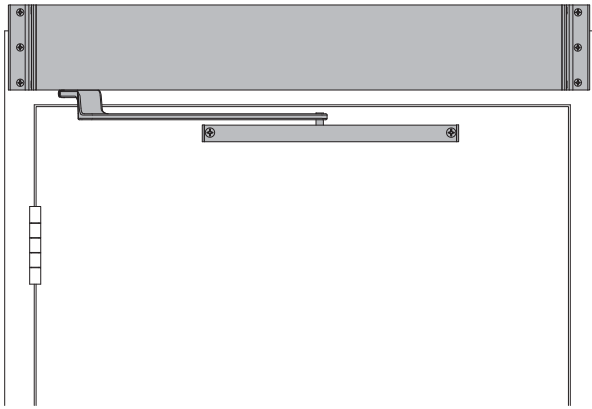

*The 9330 ASTRO SWING® by LCN is a high energy operator constructed to meet the stringent demands of high volume, high traffic environments. ASTRO SWING® operators allow flexible control over closing force, opening speed, backcheck speed, hold open duration, and more, all within ANSI guidelines.*

- ▶ **Microprocessor control box for quiet efficiency**
- ▶ **Adjustable opening, closing and backcheck speeds**
- ▶ **Tested internally up to 10,000,000 cycles**
- ▶ **Meets International Building Code requirements and ANSI A156.10**
- ▶ **Power Boost provides additional latching force**

- ▶ 9330 series operator is shipped with motor gearbox, control box, standard arm, header, and mounting hardware. Actuators available separately, see pages 199-215.
- ▶ Single door, surface mounted.
- ▶ Handed product.
- ▶ 36" header length is standard. Specify length 33" to 49" max.
- ▶ Double door header available up to 98", specify other length 49" to 98" max. Consult factory regarding this option.
- ▶ Quick connect wiring system with Molex-type plugs allows for easy field connections.

*9330 Series is fully compliant with UL 325 & UL 1998 and meets the provisions of ANSI A156.10. The 9330 Series is UL listed for fire-rated applications.*



*High Energy Operators must be ordered with guide rails & safety devices.*

MOUNTING						HANDING		FINISH		COVER		ARM FUNCTION	
<input checked="" type="checkbox"/>	<input type="checkbox"/>	<input type="checkbox"/>	<input type="checkbox"/>	<input type="checkbox"/>	<input type="checkbox"/>	<input checked="" type="checkbox"/>	<input type="checkbox"/>	<input type="checkbox"/>	<input type="checkbox"/>	<input type="checkbox"/>	<input type="checkbox"/>	<input type="checkbox"/>	<input type="checkbox"/>
SURFACE MOUNT SINGLE DOOR						HANDED		STANDARD ANODIZED		STANDARD (SINGLE)		REGULAR (DOUBLE)	
SURFACE MOUNT SIMULTANEOUS PAIR						NON-HANDED		CUSTOM ANODIZED		DOUBLE EGRESS (DOUBLE)		OFFSET PIVOT ARM (PUSH/PULL)	
SURFACE MOUNT INDEPENDENT PAIR								CUSTOM PAINT		METAL		CENTER PIVOT ARM	
CONCEALED SINGLE DOOR													
CONCEALED SIMULTANEOUS PAIR													
CONCEALED INDEPENDENT PAIR													

- AVAILABLE
- NOT AVAILABLE

# LCN 9330 SERIES

## MOUNTING DETAILS

### TOP JAMB SINGLE DOOR (OFFSET PIVOT/BUTT HINGE, PULL) MOUNTING

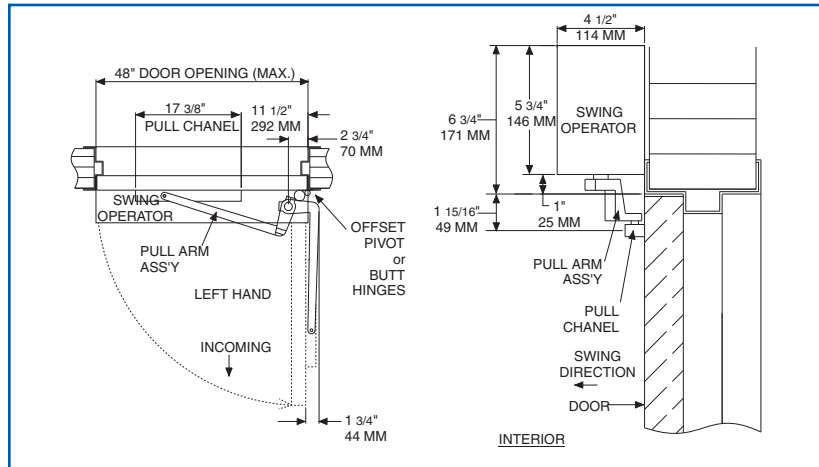

### HOLLOW METAL FRAME

Suggested Installation

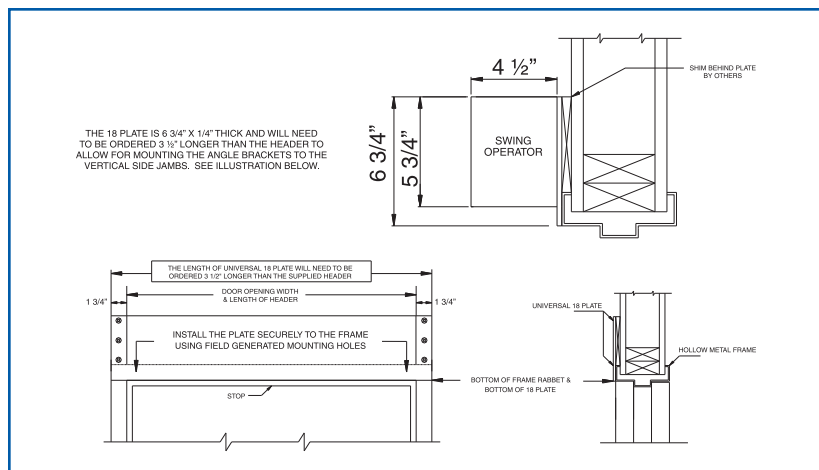

### MAXIMUM OPENING

Template allows 90 degree power opening and 90 degree manual opening.

- ▶ **Butt Hinges** should not exceed 5" (127 mm) in width.
- ▶ **Reveal** should not exceed 4" (102 mm).
- ▶ **Head Frame** minimum 1 3/4" (44 mm). Face frame 6 3/4" (171 mm) total operator clearance.
- ▶ **Top Rail** minimum 2 3/4" (70 mm).
- ▶ **Opening & Closing Time** are variable by adjustments to the electronic control box. Maximum hold open time adjustable up to approximately 32 seconds.
- ▶ **System Diagram** see "AUTOMATIC OPERATORS" section pages 54-55 for typical system wiring and page 58 for electrical data.

#### Special Templates

Customized installation templates or products may be available to solve unusual applications. Contact LCN for assistance.

## MOTOR GEARBOX

### MOTOR GEARBOX – ASTRO SWING, 9330-3454

Driving mechanism for operator. Provides 30lbs opening force. Handed.

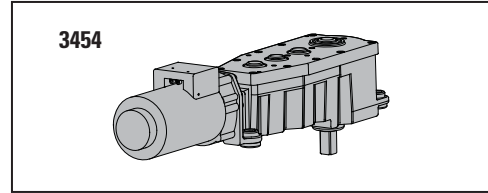

## MOUNTING BRACKETS

### MOUNTING BRACKET – 2 3/4", 9330-275

Motor gearbox mounting bracket for 2 3/4" offset pivot or butt hinge installations. Front bracket.

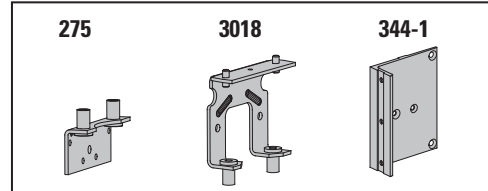

### REAR MOUNT BRACKET, 9330-3018

Motor gearbox mounting bracket. Rear bracket.

### ANGLED BRACKET, 9330-334-1

Mounting bracket for surface applications.

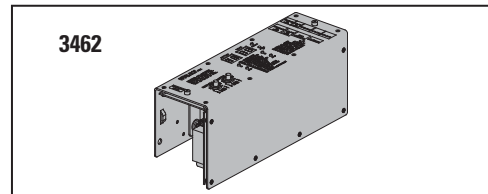

## CONTROL BOXES

### CONTROL BOX – ASTRO SWING, 9330-3462

Electronic controlling device for Astro Swing.

## HEADERS

### Header, 9330-3572HL

Standard, mounting header. Single door, single operator. Specify length 30" to 49" maximum.

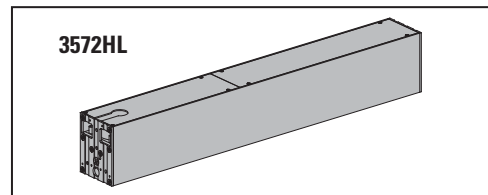

### Header, 9330-3572DD

Standard, mounting header. Double door, single operator. Specify length 49" to 98" maximum.

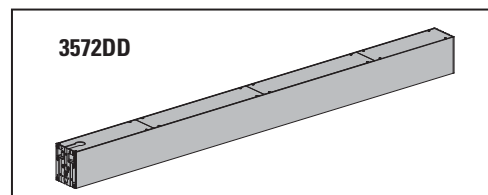

## END CAPS

### HEADER END CAPS, 9330-334

End cap with openings for wiring.

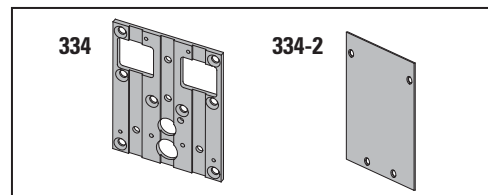

### END DRESS PLATE, 9330-334-2

Metal finish end cap.

# LCN 9330 SERIES

## ARMS

### STANDARD ARM ASSEMBLY, 9330-3077PLCM

Handed arm.

### STANDARD ARM, 9330-3077T

Handed arm. Track roller not included.

## TRACKS

### TRACK 9330-3038

Standard non-handed track.

### TRACK END CAP 9330-73

Black plastic end caps.

### ROLLER, 9330-3034

Quiet low friction roller assembly.

## INSTALLATION ACCESSORIES

### SPINDLE PLATE – 2 3/4", 9330-11A

Hides bottom of motor gearbox. Completes header box. Cutout allows for motor gearbox shaft. For 2 3/4" offset pivot or butt hinge installations.

### FILLER PLATE BLANK, 9330-12

Completes length of header box.

### MOUNTING PLATE, 9330-18

Optional mounting plate for standard hollow metal door frames. Specify length 33" to 98" maximum.

NOTE: The length of a universal 18 plate will need to be ordered 3 1/2" longer than the supplied header.

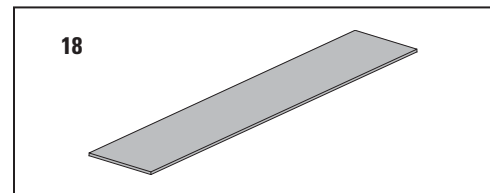
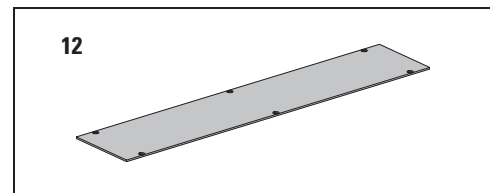
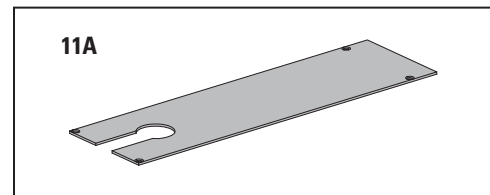
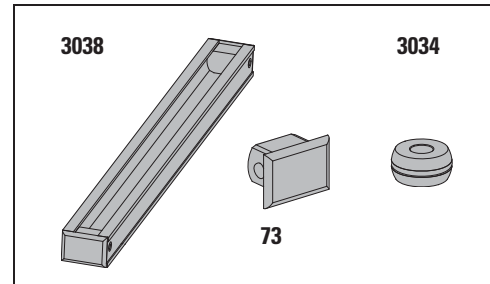
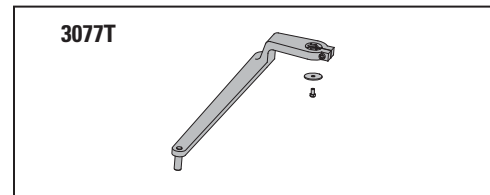
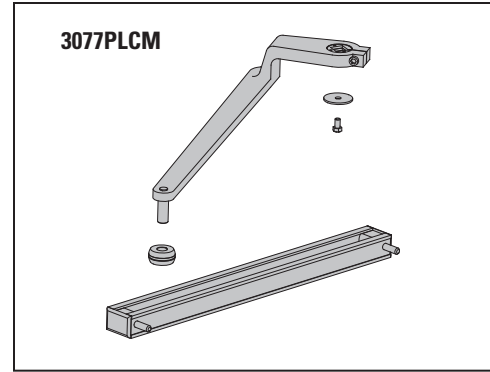

## TABLE OF SIZES

→ Indicates recommended range of door width for operator.  
 Note: For all Astro Swing Series  
 Single Door - Width per leaf 36" minimum, 48" maximum

### DOOR WIDTH

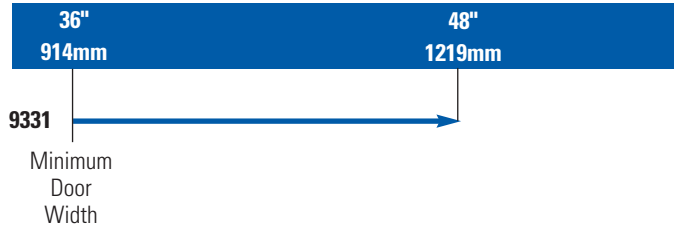

## HOW-TO-ORDER 9330 SERIES OPERATORS

### 1. SPECIFY HAND

- RH
- LH

### 2. SPECIFY FINISH.

- Standard Anodized Finish \_\_\_\_\_  
 Aluminum or Dark Bronze

#### **Operator will be shipped with:**

- STANDARD MOTOR GEARBOX (SF)
  - STANDARD CONTROL BOX (SC)
  - 36" HEADER (36HL)
  - STANDARD ARM (3077T)
  - 2 3/4" PIVOT POINT
  - STANDARD TRACK w/TRACK ROLLER
  - WOOD and MACHINE SCREW PACK
- Unless options listed below are selected.*

## OPERATOR OPTIONS

### HEADER

- HL\_\_ (Specify length 33" to 49")
- DD\_\_ (Specify length 49" to 98")

### MOUNTING PLATE

- Plate, \_\_\_\_ (Specify Length)

### FINISH

- Custom Anodized Finish \_\_\_\_\_
- Custom Painted Finish \_\_\_\_\_

### SPECIAL TEMPLATE

- ST-\_\_\_\_\_