

SINGLE DOOR, SURFACE MOUNT (PULL) OFFSET PIVOT/BUTT HINGE

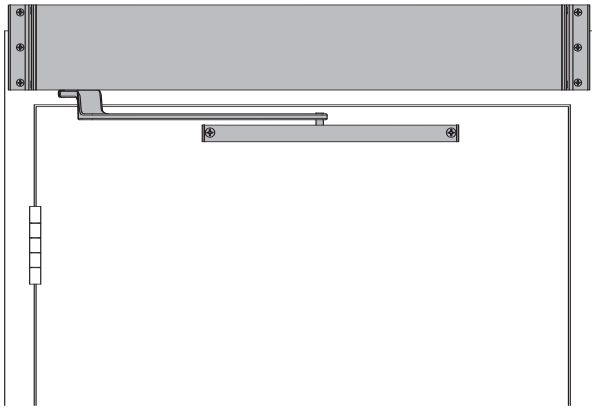

The 9530 SENIOR SWING by LCN is an ADA door operator that is a two-in-one swing door operator. SENIOR SWING operators when activated, opens doors automatically for wheelchair access, yet allows for manual operation for regular pedestrian traffic.

- ▶ **Push 'N Go permits non-switch activation**
- ▶ **Power Boost provides additional latching force**
- ▶ **Electromechanical unit with microprocessor control**
- ▶ **Digital keypad for easy setup**
- ▶ **Tested internally to over 10,000,000 cycles**
- ▶ **Meets International Building Code requirements and ANSI A156.19**
- ▶ **UL approved for fire doors**

- ▶ 9530 series operator is shipped with motor gearbox, control box, standard arm, header, and mounting hardware. Actuators available separately, see pages 199-215.
- ▶ Single door, surface mounted.
- ▶ Meets ADA requirements (power mode only).
- ▶ Handed product.
- ▶ 36" header length is standard. Specify length 33" to 49" max.
- ▶ Double door header available up to 98", specify other length 49" to 98" max. Consult factory regarding this option.
- ▶ Adjustable hold open period of 2 to 32 seconds in automatic or manual mode.

9530 Series is fully compliant with UL 325 & UL 1998 and meets the provisions of ANSI A156.19. The 9530 Series is UL listed for fire-rated applications. The 9530 Series also meets the provisions of the Americans with Disabilities Act.

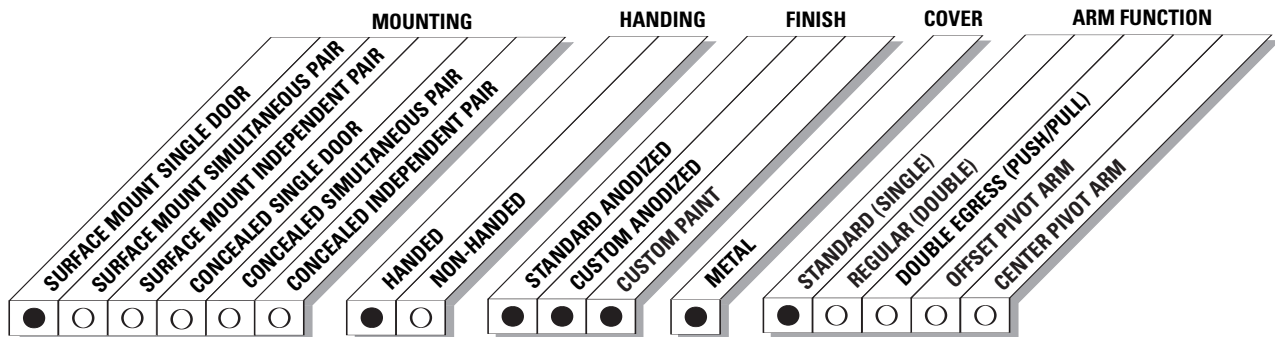

● AVAILABLE
○ NOT AVAILABLE

LCN 9530 SERIES

MOUNTING DETAILS

TOP JAMB SINGLE DOOR (OFFSET PIVOT/BUTT HINGE, CENTER PIVOT, PULL) MOUNTING

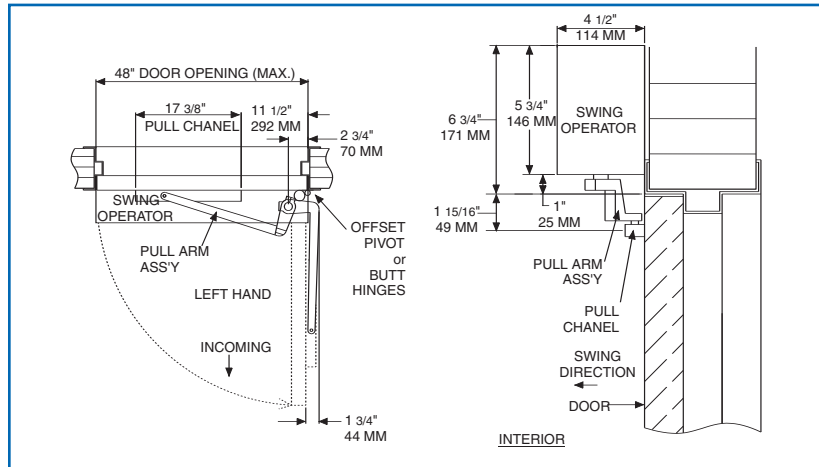

HOLLOW METAL FRAME

Suggested Installation

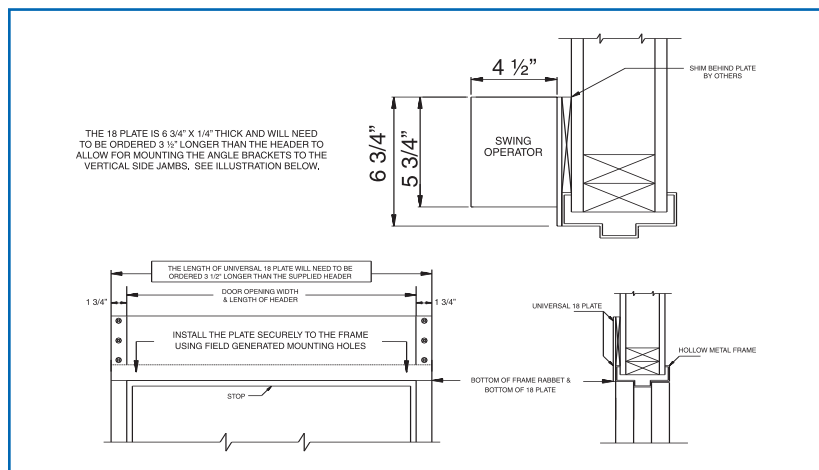

MAXIMUM OPENING

Template allows 90 degree power opening and 90 degree manual opening.

Special Templates

Customized installation templates or products may be available to solve unusual applications. Contact LCN for assistance.

- ▶ **Butt Hinges** should not exceed 5" (127 mm) in width.
- ▶ **Reveal** should not exceed 4" (102 mm).
- ▶ **Head Frame** minimum 1 3/4" (44 mm). Face frame 6 3/4" (171 mm) total operator clearance.
- ▶ **Top Rail** minimum 2 3/4" (70 mm).
- ▶ **Opening & Closing Time** are variable by adjustments to the electronic control box. Maximum hold open time adjustable up to approximately 32 seconds.
- ▶ **System Diagram** see "AUTOMATIC OPERATORS" section pages 54-55 for typical system wiring and page 58 for electrical data.
- ▶ Please consult your local SSC representative or LCN for assistance with specific installations and material requirements.

MOTOR GEARBOX

MOTOR GEARBOX (STANDARD FORCE) – SENIOR SWING, 9530-3454

Driving mechanism for operator. Provides 15lbs opening force. Handed.

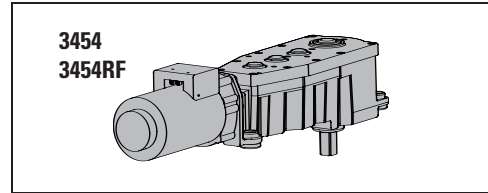

MOTOR GEARBOX (REDUCED FORCE) – SENIOR SWING, 9530-3454RF

Driving mechanism for operator. Provides 11lbs opening force. Handed.

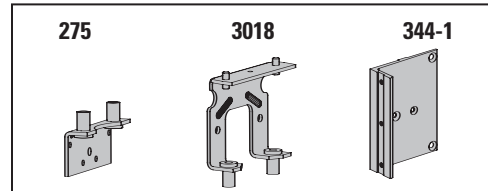

MOUNTING BRACKET

MOUNTING BRACKET – 2 3/4", 9530-275

Motor gearbox mounting bracket for 2 3/4" offset pivot or butt hinge installations. Front bracket.

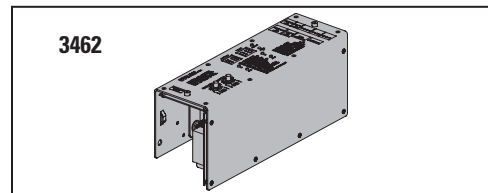

REAR MOUNT BRACKET, 9530-3018

Motor gearbox mounting bracket. Rear bracket.

ANGLED BRACKET, 9530-334-1

Mounting bracket for surface applications.

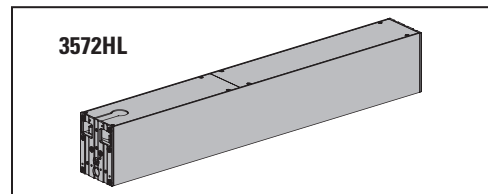

CONTROL BOXES

CONTROL BOX – SENIOR SWING, 9530-3462

Electronic controlling device for Senior Swing.

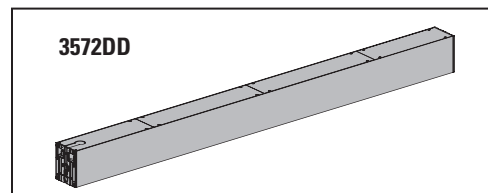

HEADERS

Header, 9530-3572HL

Standard, mounting header. Single door, single operator. Specify length 30" to 49" maximum.

Header, 9530-3572DD

Standard, mounting header. Double door, single operator. Specify length 49" to 98" maximum.

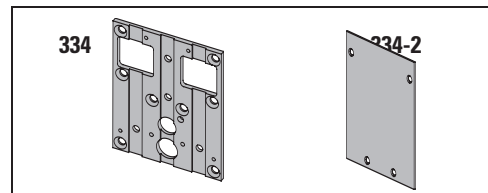

END CAPS

HEADER END CAPS, 9530-334

End cap with openings for wiring.

END DRESS PLATE, 9530-334-2

Metal finish end cap.

LCN 9530 SERIES

ARMS

STANDARD ARM ASSEMBLY, 9530-3077PLCM

Handed arm.

STANDARD ARM, 9530-3077T

Handed arm. Track roller not included.

TRACKS

TRACK 9530-3038

Standard non-handed track.

TRACK END CAP 9530-73

Black plastic end caps.

ROLLER, 9530-3034

Quiet low friction roller assembly.

INSTALLATION ACCESSORIES

SPINDLE PLATE – 2 3/4", 9530-11A

Hides bottom of motor gearbox. Completes header box. Cutout allows for motor gearbox shaft. For 2 3/4" offset pivot or butt hinge installations.

FILLER PLATE BLANK, 9530-12

Completes length of header box. (Specify Length)

MOUNTING PLATE, 9530-18

Optional mounting plate for standard hollow metal door frames. Specify length 33" to 98" maximum.

NOTE: The length of a universal 18 plate will need to be ordered 3 1/2" longer than the supplied header.

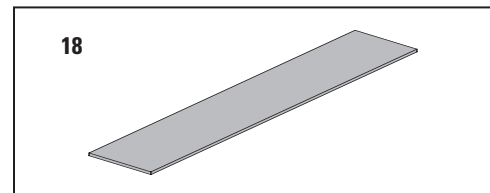
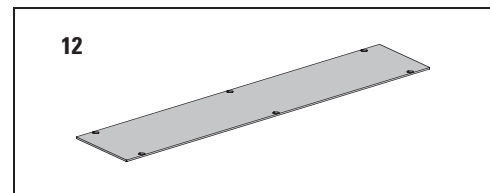
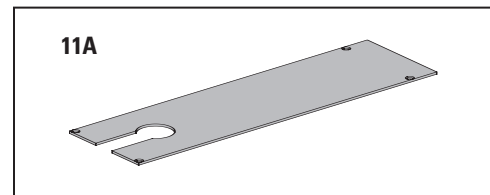
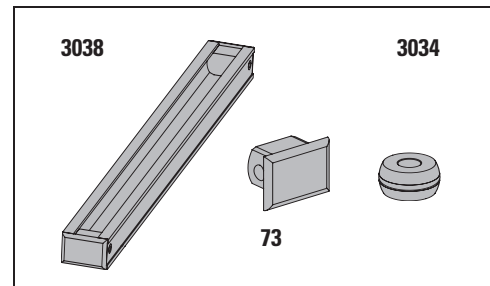
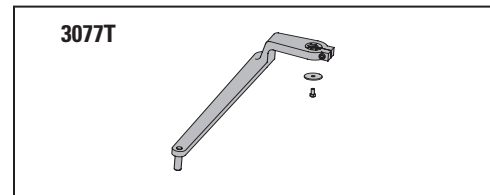
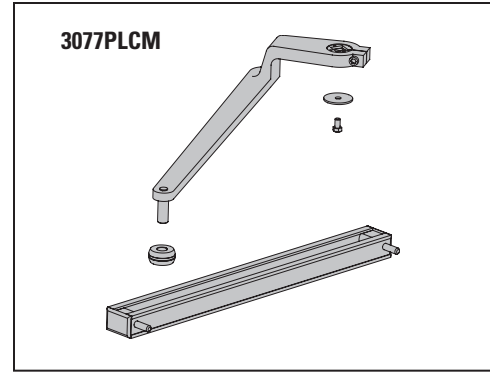
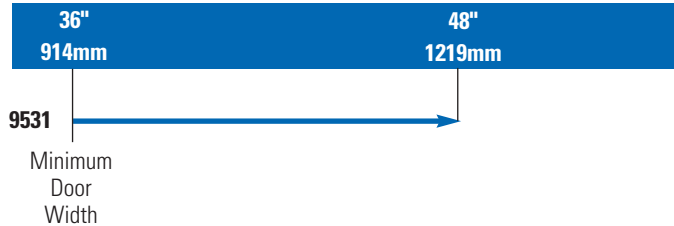

TABLE OF SIZES

→ Indicates recommended range of door width for operator.
 Note: For all Senior Swing Series
 Single Door - Width per leaf 36" minimum, 48" maximum

DOOR WIDTH



HOW-TO-ORDER 9530 SERIES OPERATORS

1. SPECIFY HAND

- RH
- LH

2. SPECIFY FINISH.

- Standard Anodized Finish _____
 Aluminum or Dark Bronze

Operator will be shipped with:

- STANDARD MOTOR GEARBOX (SF)
 - STANDARD CONTROL BOX (SC)
 - 36" HEADER (36HL)
 - STANDARD ARM (3077T)
 - 2 3/4" PIVOT POINT
 - STANDARD TRACK w/TRACK ROLLER
 - MACHINE SCREW PACK
- Unless options listed below are selected.*

OPERATOR OPTIONS

MOTOR GEARBOX

- Reduced Force Motor Gearbox (RF)

HEADER

- HL ___ (Specify length 36" to 49")
- DD___ (Specify length 49" to 98")

MOUNTING PLATE

- Plate, _____ (Specify Length 30" to 98")

FINISH

- Custom Anodized Finish _____
- Custom Painted Finish _____

SPECIAL TEMPLATE

- ST-_____